

## Model No. DBMX300

Performance / Rendimiento / Prestanda

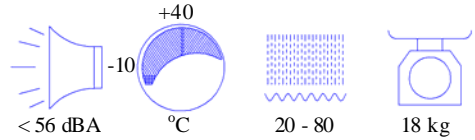

★ Allowance :  $\pm 5\%$

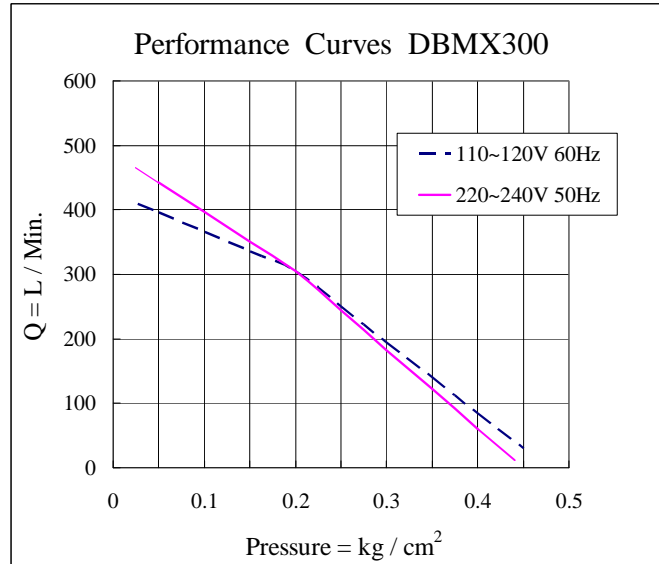

### Exhaust

Dimensions / Dimensioner (mm)

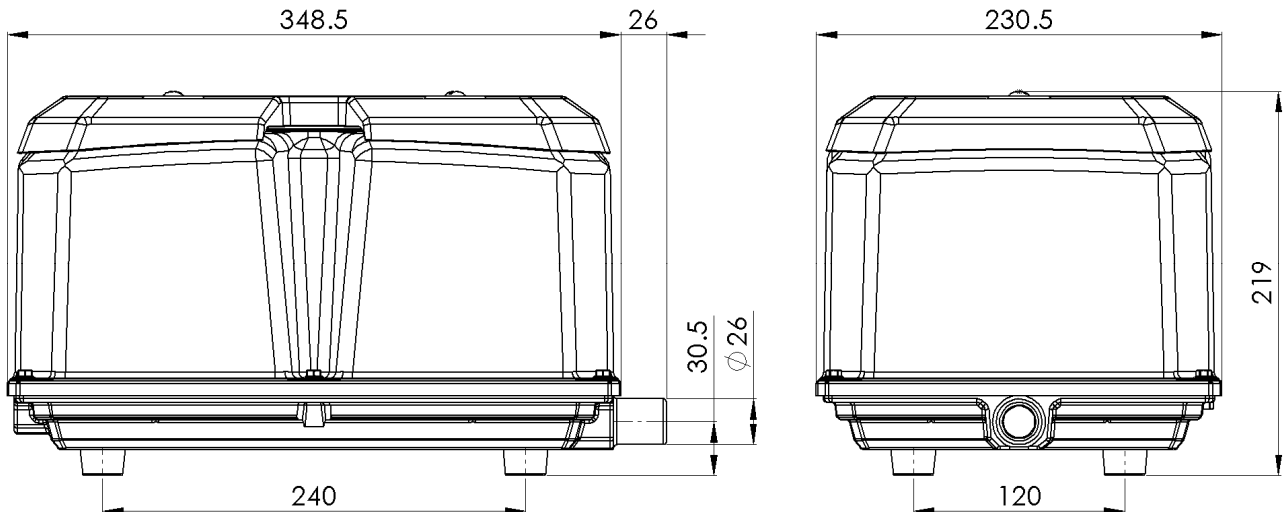

**Operating range : 0.1 to 0.28 kg/cm<sup>2</sup>**

Model No.	Voltage (VAC)	Frequency (HZ)	Rated Pressure (kg/cm <sup>2</sup> )	Airflow (LPM)	AMP (A)	WATT (W)
DBMX300	110 ~ 120	60	0.2	300	4.3	281
DBMX300	220 ~ 240	50	0.2	300	2.6	298

**Diann Bao Inc.**

[www.airmac.com.tw](http://www.airmac.com.tw)

✉ E-mail: [airmac@airmac.com.tw](mailto:airmac@airmac.com.tw)

☎ Tel: +886-4-7621838

☎ Fax: +886-4-7617617